



WELDING LATHE

Art. TS750

Capacity load: 750 Kg

Layout: min. 2500x2400 mm
max. 4000x4500 mm

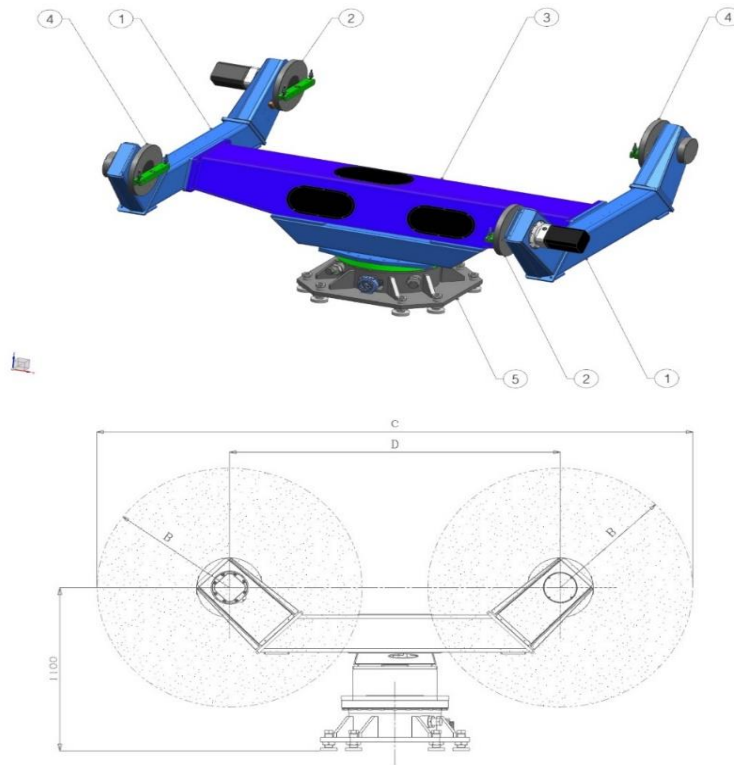

Description

* variable measures

A	E + 1000 mm
B*	from 500 to 1000 mm
C	D + 2B
D	from 1400 to 2500 mm
E*	from 1500 to 3000 mm
F	from 1460 to 2700 mm

SUBTOTAL, EX-WORKS

from € 25.500,00 to € 28.500,00

Exclusion

Installation, wiring, debug and tests