



TORNIO DI SALDATURA

Art. TS500

Portata: 500 Kg

Layout: min. 2500x2400 mm
max. 4000x4500 mm

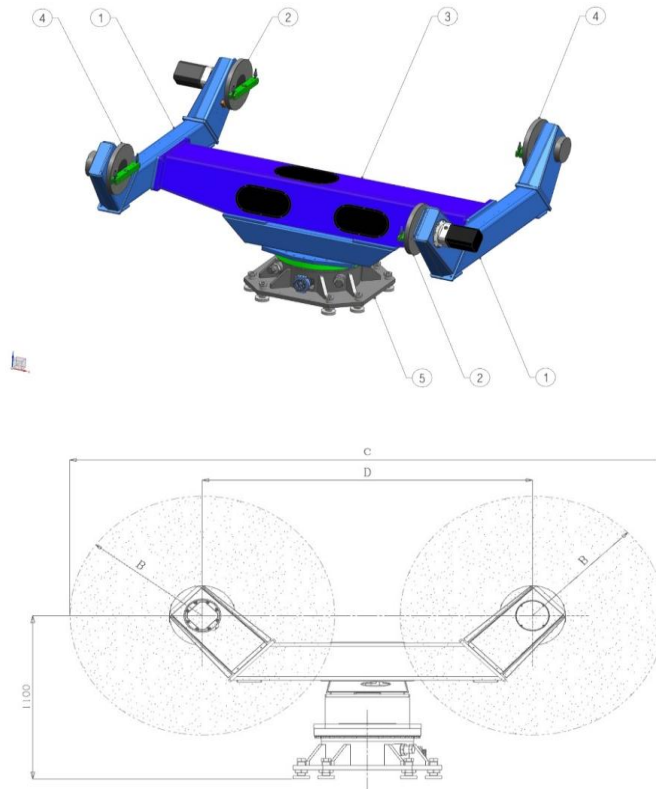

Descrizione

* misure variabili

A	E + 1000 mm
B*	da 500 a 1000 mm
C	D + 2B
D	da 1400 a 2500 mm
E*	da 1500 a 3000 mm
F	da 1460 a 2700 mm

SUBTOTALE, EX-WORKS

da € 23.500,00 a € 26.500,00 (+IVA)

Esclusioni

Installazione, cablaggio, prove e collaudo